

Electronic pressure switch with display For sanitary applications Model PSA-31

WIKA data sheet PE 81.85



for further approvals see
page 8



Applications

- Food and beverage industry
- Pharmaceutical industry
- Filling and packing machinery
- Sanitary applications

Special features

- Easily readable, robust display
- Intuitive and fast setup
- Easy and flexible mounting configurations



Pressure switch model PSA-31

Description

Award-winning in design and functionality

The successful design and the excellent functionality of the WIKA switch family were already confirmed by winning the "iF product design award 2009" for the pressure switch model PSD-30.

The robust LED display has been designed using 9 mm high characters (the largest possible) and with a slight incline in order to make reading the prevailing pressure as easy as possible from a long way off. The use of a 14-segment display ensures a clear display and readability of letters. The 3-key operation makes simple, intuitive menu navigation possible, with no need for additional assistance. The menu navigation conforms to the latest VDMA standard. The VDMA standard for fluid sensors (24574-1, part 1 - pressure switches) has the aim of simplifying the use of pressure switches by standardising menu navigation and display.

The control keys have been designed as large as possible and are arranged ergonomically to ensure fast and easy adjustments. Operation without any additional assistance is made easier through the tactile feedback.

Customised installation

The installation of the PSA-31 can be flexibly adapted to the individual mounting situation. Due to the almost unlimited rotation of the display and case by more than 300°, the display can be adjusted independently of the electrical connection. The display can thus always be aligned to face the operator, and the M12 x 1 connection positioned to suit the desired cable routing.

High quality

During development of the WIKA switch family a high value was placed on a robust design and the selection of appropriate materials suited to machine-building applications. For this reason the case and the threaded connection of the electrical connector are made from stainless steel. Overwinding or tearing off the connector is therefore virtually impossible.

IO-Link

With the optional output signal in accordance with the IO-Link communication standard, the PSA-31 allows a fast integration into modern automation systems. IO-Link offers an even faster installation, parameterisation and higher functionality of the PSA-31.

Measuring ranges

Gauge pressure								
bar	0 ... 1	0 ... 1.6	0 ... 2.5	0 ... 4	0 ... 6	0 ... 10	0 ... 16	0 ... 25
psi	0 ... 15	0 ... 25	0 ... 30 ¹⁾	0 ... 50	0 ... 100	0 ... 160	0 ... 200	0 ... 300

Absolute pressure								
bar	0 ... 1	0 ... 1.6	0 ... 2.5	0 ... 4	0 ... 6	0 ... 10	0 ... 16	0 ... 25
psi	0 ... 15	0 ... 25	0 ... 30 ¹⁾	0 ... 50	0 ... 100	0 ... 160	0 ... 200	0 ... 300

Vacuum and +/- measuring range								
bar	-1 ... 0	-1 ... +1.5	-1 ... +3	-1 ... +5	-1 ... +9	-1 ... +15	-1 ... +24	
psi	-14.5 ... 0	-14.5 ... +30	-14.5 ... +50	-14.5 ... +100	-14.5 ... +160	-14.5 ... +200	-14.5 ... +300	

The given measuring ranges are also available in kg/cm² and MPa.

Overpressure limit

2 times

1.7 times for gauge pressure measuring range 160 psi

Display

14-segment LED, red, 4-digit, 9 mm character size

Display can be turned electronically by 180°

Update (adjustable): 100, 200, 500 or 1,000 ms

Output signals

Switching output		Analogue signal
SP1	SP2	
PNP	-	4 ... 20 mA (3-wire)
PNP	-	DC 0 ... 10 V (3-wire)
PNP	PNP	4 ... 20 mA (3-wire)
PNP	PNP	DC 0 ... 10 V (3-wire)

Optionally also available with an NPN instead of a PNP switching output

IO-Link, revision 1.1 (option)

IO-Link is optionally available for all output signals.

With the IO-Link option, switching output SP1 is always PNP

Zero offset adjustment

max. 3 % of span

Switching thresholds

Switch point 1 and switch point 2 are individually adjustable

Switching functions

Normally open, normally closed, window, hysteresis

Freely adjustable

Switching voltage

Power supply - 1 V

Switching current

- without IO-Link: max. 250 mA
- with IO-Link: SP1 max. 100 mA
SP2 max. 250 mA

Settling time

Analogue signal: 3 ms

Switching output: ≤ 10 ms (20 ms with IO-Link)

Load

Analogue signal 4 ... 20 mA: ≤ 0.5 kΩ

Analogue signal DC 0 ... 10 V: > 10 kΩ

Service life

100 million switching cycles

Voltage supply

Power supply

DC 15 ... 35 V

Current consumption

Switching outputs with

- Analogue signal 4 ... 20 mA: 70 mA
- Analogue signal DC 0 ... 10 V: 45 mA

IO-Link option causes a deviating current consumption

Total current consumption

- without IO-Link: max. 600 mA including switching current
- with IO-Link: max. 450 mA including switching current

Accuracy specifications

Accuracy, analogue signal

$\leq \pm 1.0$ % of span

Including non-linearity, hysteresis, zero offset and end value deviation (corresponds to measured error per IEC 61298-2). Calibrated in vertical mounting position with process connection facing downwards.

Non-linearity: $\leq \pm 0.5$ % of span (BFSL, IEC 61298-2)

Long-term drift: $\leq \pm 0.2$ % of span (IEC 61298-2)

Accuracy, switching output

Switch point accuracy: $\leq \pm 1$ % of span

Adjustment accuracy: $\leq \pm 0.5$ % of span

Display

$\leq \pm 1.0$ % of span ± 1 digit

Typical temperature coefficient of zero point

- Clamp DIN 32676, DN 32
 - 0 ... 20 °C: 0.75 % of span/10 K
 - 20 ... 80 °C: 0.45 % of span/10 K
- All other process connections
 - 0 ... 20 °C: 0.7 % of span/10 K
 - 20 ... 80 °C: 0.2 % of span/10 K

Typical temperature coefficient of span

All process connections

0 ... 80 °C: 0.1 % of span/10 K

Reference conditions

Temperature: 15 ... 25 °C (59 ... 77 °F)

Atmospheric pressure: 950 ... 1,050 mbar (13.78 ... 15.23 psi)

Humidity: 45 ... 75 % r. h.

Nominal position: Process connection lower mount (LM)

Power supply: DC 24 V

Load: see "Output signals"

Operating conditions

Permissible temperature ranges

Ambient: -20 ... +80 °C

Storage: -20 ... +80 °C

Rated temperature range: 0 ... 80 °C

Medium temperature depending on the process connection

- G1 hygienic
 - 20 ... +125 °C (+150 °C possible for up to 60 minutes)
- All other process connections
 - 20 ... +100 °C (+135 °C possible for up to 60 minutes)

Humidity

45 ... 75 % r. h.

Vibration resistance

10 g (IEC 60068-2-27, vibration under resonance)

Shock resistance

50 g (per IEC 60068-2-6, mechanical shock)

Ingress protection

IP 65 and IP 67

The stated ingress protection (per IEC 60529) only applies when plugged in using mating connectors that have the appropriate ingress protection.

Mounting position

as required

Process connections

Standard	Thread
Hygienic	G 1, flush ¹⁾²⁾
Grooved union nut DIN 11851 with conical coupling ³⁾	DN 40 DN 50
Tri-clamp	1 1/2" 2"
Clamp DIN 32676	DN 32 DN 40 DN 50

1) Sealing from EPDM or FKM

2) Suitable for WIKA adapter system model 910.61; see data sheet AC 09.20

3) For a 3-A conform connection of process connections with milk thread fittings per DIN 11851, profile sealings from SKS Komponenten BV or Kieselmann GmbH have to be used.

Surface roughness of wetted parts

Ra ≤ 0.4 µm (except for weld seam)

Electrical connections

Connections

- Circular connector M12 x 1, 4-pin
- Circular connector M12 x 1, 5-pin ¹⁾

1) Only for version with two switching outputs and additional analogue signal

Electrical safety

Overvoltage protection: DC 40 V

Short-circuit resistance: S₊ / SP1 / C / SP2 vs. U-

Reverse polarity protection: U₊ vs. U-

Insulation voltage: DC 500 V

Connection diagrams

Circular connector M12 x 1 (4-pin)		
	U ₊	1
	U ₋	3
	S ₊	2
	SP1/C	4

Circular connector M12 x 1 (5-pin)		
	U ₊	1
	U ₋	3
	S ₊	5
	SP1/C	4
	SP2	2

Legend

- U₊ Positive power supply
- U₋ Negative power supply
- S₊ Analogue output
- SP1 Switching output 1
- SP2 Switching output 2
- C Communication with IO-Link

Materials

Wetted parts

Process connection: Stainless steel 1.4435 / 316L

Non-wetted parts

Case: Stainless steel 304

Keypad: TPE-E

Display window: PC

Display head: PC+ABS blend

Pressure transmission medium

KN92 medicinal white mineral oil, FDA conform per CFR

172.878 and 21 CFR 178.3620(a); conform to USP, EP and

JP

Process connections and dimensions in mm

Pressure switch

with G1 hygienic

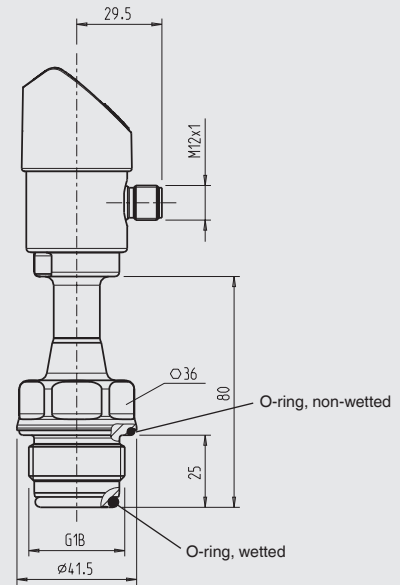
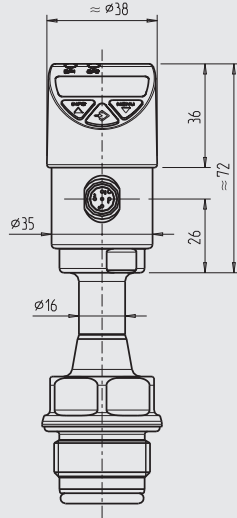

Sealing from EPDM or FKM

Suitable for WIKA adapter system model 910.61; see data sheet AC 09.20

For dimensions of the appropriate process adapters and welding sockets see data sheet AC 09.20

with clamp

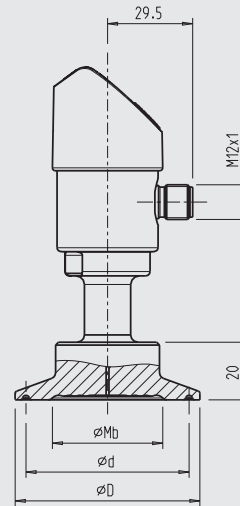
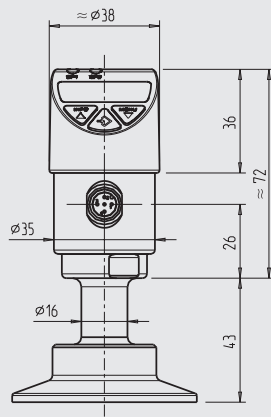

Version		Dimensions in mm		
		ØMb	Ød	ØD
DIN 32676	DN 32	29	43.5	50.5
	DN 40	32	43.5	50.5
	DN 50	40	56.6	64
Tri-clamp	1 1/2"	32	43.5	50.5
	2"	40	56.6	64

1) EHEDG conformity with clamp connection only in combination with a Kalrez® stainless steel gasket from Dupont de Nemours or with a T-ring seal from Combifit International B.V.

with grooved union nut DIN 11851

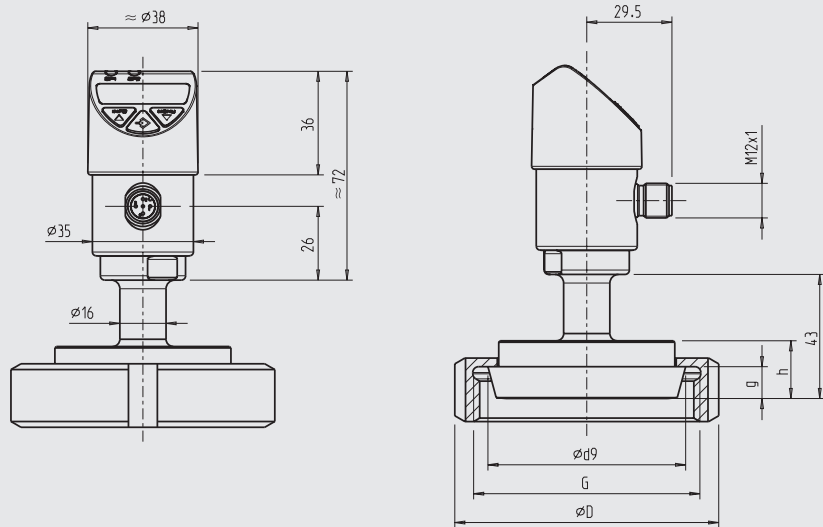

1)



2)







Version		Dimensions in mm				
		Ød9	G	ØD	g	h
DIN 11851	DN 40	56	Rd 65 x 1/6	78	10	20
	DN 50	68.5	Rd 78 x 1/6	92	11	20

1) For a 3-A conform connection of process connections with milk thread fittings per DIN 11851, profile sealings from SKS Komponenten BV or Kieselmann GmbH have to be used.

2) Ehedg conformity with connection per DIN 11851 only in combination with ASEPTO-STAR K-flex upgrade, sealing from Kieselmann GmbH.

Other process connections available on request.

Approvals

Logo	Description	Country
	EC declaration of conformity EMC directive 2004/108/EC, EN 61326 emission (group 1, class B) and interference immunity (industrial application)	European Community
	EAC Electromagnetic compatibility	Eurasian Economic Community
	GOST Metrology, measurement technology	Russia
	KazInMetr Metrology, measurement technology	Kazakhstan
	MtschS Permission for commissioning	Kazakhstan
	3-A Sanitary Standard This instrument is 3-A marked based on a third party verification for conformance to the 3-A standard 74-06.	USA
	EHEDG Hygienic Equipment Design	European Community

Manufacturer's information and certifications

- RoHS conformity 2011/65/EU
- Manufacturer's declaration regarding EU regulation 1935/2004 EC

Certificates

- Material certificate per EN 10204-3.1
 - Confirmation of the class and indication accuracy
 - FDA conformity
- Others on request

Approvals and certificates, see website

Accessories and spare parts

Sealings for G1 hygienic, wetted

Dimensions: 21.82 x 3.53 mm



Material	Colour	Temperature range	Conformity to	Order no.
EPDM 70	black	-40 ... +145 °C	FDA 21 CFR 177.2600, USP XXV class VI and 3-A (18-03) Sanitary Standards class 2 (max. 8 % milk fat)	14004173
FKM 75	black	-15 ... +200 °C	FDA 21 CFR 177.2600, USP XXIII class VI and 3-A (18-03) Sanitary Standards class 1	14004174

Sealings for G1 hygienic, not wetted

Dimensions: 35 x 2.5 mm

Material	Colour	Temperature range	Conformity to	Order no.
EPDM 70	black	-40 ... +145 °C	-	14023833

Connectors with moulded cable

	Description	Temperature range	Cable diameter	Order no.
	Straight version, cut to length, 4-pin, 2 m PUR cable, UL listed, IP 67	-20 ... +80 °C	4.5 mm	14086880
	Straight version, cut to length, 4-pin, 5 m PUR cable, UL listed, IP 67	-20 ... +80 °C	4.5 mm	14086883
	Straight version, cut to length, 4-pin, 10 m PUR cable, UL listed, IP 67	-20 ... +80 °C	4.5 mm	14086884
	Straight version, cut to length, 5-pin, 2 m PUR cable, UL listed, IP 67	-20 ... +80 °C	5.5 mm	14086886
	Straight version, cut to length, 5-pin, 5 m PUR cable, UL listed, IP 67	-20 ... +80 °C	5.5 mm	14086887
	Straight version, cut to length, 5-pin, 10 m PUR cable, UL listed, IP 67	-20 ... +80 °C	5.5 mm	14086888
	Angled version, cut to length, 4-pin, 2 m PUR cable, UL listed, IP 67	-20 ... +80 °C	4.5 mm	14086889
	Angled version, cut to length, 4-pin, 5 m PUR cable, UL listed, IP 67	-20 ... +80 °C	4.5 mm	14086891
	Angled version, cut to length, 4-pin, 10 m PUR cable, UL listed, IP 67	-20 ... +80 °C	4.5 mm	14086892
	Angled version, cut to length, 5-pin, 2 m PUR cable, UL listed, IP 67	-20 ... +80 °C	5.5 mm	14086893
	Angled version, cut to length, 5-pin, 5 m PUR cable, UL listed, IP 67	-20 ... +80 °C	5.5 mm	14086894
	Angled version, cut to length, 5-pin, 10 m PUR cable, UL listed, IP 67	-20 ... +80 °C	5.5 mm	14086896

Ordering information

Model / Measuring range / Number of switching outputs / Type of switching output / Analogue signal / Process connection /
Certificates / Accessories and spare parts

© 2011 WIKA Alexander Wiegand SE & Co. KG, all rights reserved.
The specifications given in this document represent the state of engineering at the time of publishing.
We reserve the right to make modifications to the specifications and materials.