



From process to measurement

Instrumentation valves and mounting accessories



Smart in sensing



Alexander Wiegand,
Chairman and CEO, WIKA

About us

As a family-run business acting globally, with 10,200 highly qualified employees, the WIKA group of companies is a worldwide leader in pressure and temperature measurement. The company also sets the standard in the measurement of level, force and flow, and in calibration technology.

Founded in 1946, WIKA is today a strong and reliable partner for all the requirements of industrial measurement technology, thanks to a broad portfolio of high-precision instruments and comprehensive services.

With manufacturing locations around the globe, WIKA ensures flexibility and the highest delivery performance. Every year, over 50 million quality products, both standard and customer-specific solutions, are delivered in batches of 1 to over 10,000 units.

With numerous wholly owned subsidiaries and partners, WIKA competently and reliably supports its customers worldwide. Our experienced engineers and sales experts are your competent and dependable contacts locally.

Contents

Industries and applications	4
Prevent fugitive emissions	5
Combinations with measuring instruments via flange connections	6
Combinations with measuring instruments via threaded connections	8
The products in comparison	10
Instrumentation valves	12
Needle and multiport valve	Models IV10, IV11 12
Block-and-bleed valve	Models IV20, IV21 12
Valve manifold for differential pressure measuring instruments	Models IV30, IV31 13
Valve manifold for differential pressure measuring instruments	Models IV50, IV51 13
Ball valve, process and instrument version	Model BV 14
Check valve	Model CV 14
Monoflange, process and instrument version	Model IVM 15
Monoblock with threaded connection	Models IBM2, IBM3 16
Monoblock with flange connection	Models IBF1, IBF2, IBF3 16
Special valves	13
High-pressure needle valve	Model HPNV 17
Monoblock for sampling and injection processes	Models IBS3, IBJ4 17
Stopcock	Model 910.10 18
Shut-off valve	Model 910.11 18
Protective devices	19
Snubber	Model 910.12 19
Overpressure protectors, adjustable	Model 910.13 19
Syphon	Model 910.15 19
Mounting accessories	20
Connection adapter	Model 910.14 20
Instrument mounting bracket	Model 910.16 20
Sealings	Model 910.17 20
Special applications and approvals	21
WIKA worldwide	24

WIKA is a reliable supplier of valves and instrumentation with appropriate accessories. Thanks to the ready-to-install instrument connections, the customer receives a complete, application-specific solution that is already tested and ready for use. This results in cost and time savings for our customers.

Our valves are available with certification for fugitive emissions, fire-safe designs and with tamper-proof, lockable handles, ensuring safety for the operator, the plant and the environment.

Thanks to our worldwide network, there is always a WIKA subsidiary near you to find the best solution for your application.

We are happy to support you in the selection of the correct components for your application. Alongside the extensive selection of instrumentation valves and accessories, WIKA also offers qualified assembly of different individual components into a complete measuring arrangement (instrument hook-up).

Industries and applications

Our wide range of valves and instrument hook-ups are used for gaseous, liquid, aggressive, highly viscous or crystallising media, also in aggressive environments. They are suitable for demanding applications in diverse industries.

- First shut-off valve for pressure tap to local instrument installation
- Media distribution, drain or vent in pipelines
- Direct connection of pressure measuring instruments to pipelines or vessels
- Wellhead control panels (WHCPs) and hydraulic power units (HPUs)
- Injection systems
- Sampling systems for process analysis
- Actuator controls
- Hydraulic power packs
- Test benches and calibration equipment
- Level measuring instruments and level indicators
- Blasting/cutting with water and high-pressure cleaning

Oil & gas



Chemical & petrochemical industries



Food & pharmaceuticals

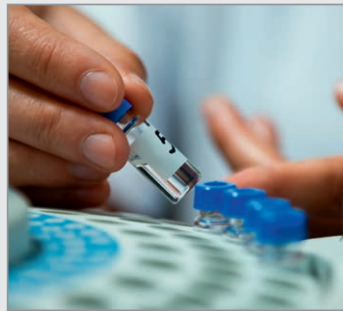

Power generation

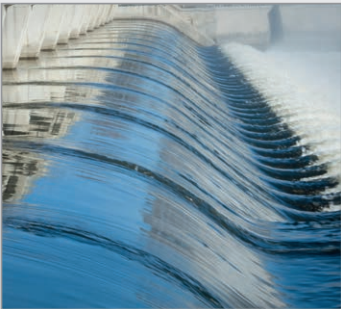

Water and wastewater

Machine building and automation

Power plants

Shipbuilding

Prevent fugitive emissions

Our needle valves can be supplied in accordance with EN-ISO 15848-1 and VDI 2440. The bonnets of these valves thus offer the following safety-relevant features: blow-out-proof valve spindle, non-rotating spindle tip with metal seat (low-wear operation), low torque for smooth and precise valve adjustment, even at high pressures.

The “fugitive emission” version also offers a special sealing packing made of RTFE, a reinforced PTFE. The corresponding valves are supplied with an orange ring on the bonnet and are thus clearly identifiable.

In addition to the needle valves, model BV ball valves as well as the IBM and IBF monoblocks are also approved by the ABS Group in accordance with the international EN-ISO 15848-1 standard for fugitive emissions.

Our valve manufacturing facility has also been equipped with a new state-of-the-art liquid and gas test bench, which enables us to perform a variety of tests from -196 ... + 350 °C [-320 ... +662 °F] in-house, such as:

- Type test and certificate for fugitive emissions
- Low-temperature test and certificate down to -196 °C
- High-temperature test up to 350 °C
- Tests and certificate for low emissions
- High-pressure gas test
- Validation of the design and test bench temperature/pressure range



Safety for personnel



Safety for the environment



Safety for the instruments



Combinations with measuring instruments via flange connections



+

Monoblock			Monoflange
IBF1 (Block)	IBF2 (Block-and-bleed)	IBF3 (Double-block-and-bleed)	IVM (Block / Block-and-bleed / Double-block-and-bleed)

+



+

+

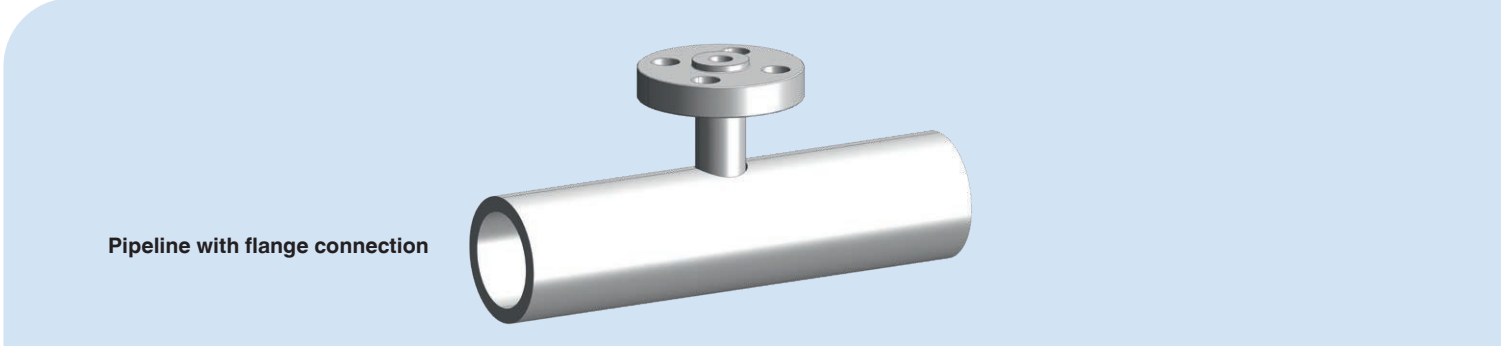



+

Flushing ring



Flushing ring



Flushing ring with single needle valve

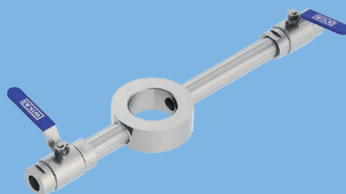

Flushing ring with double ball valve

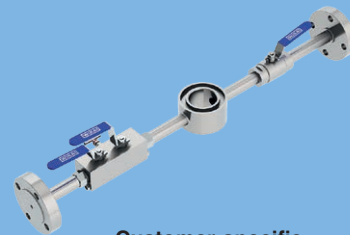

Customer-specific flushing ring

+



IBF (Monoblock)

+

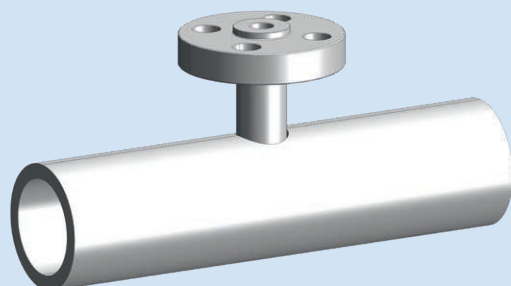





Pipeline with flange connection

Combinations with measuring instruments via threaded connections

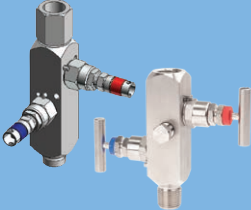

+

Flange adapter without valve		Flange adapter with valve			Monoflange
					
910.14 Flange with connection adapter	910.14 Flange with integrated connection adapter	IV1x Block / Multiport	IV2x Block-and-bleed	DIN shut-off valve Block / Block-and-bleed / Double-block-and-bleed	IVM Block / Block-and-bleed / Double-block-and-bleed

+

+



910.14
Flange with connection adapter

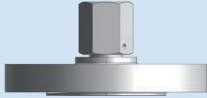

910.14
Flange with integrated connection adapter

+

+



Monoblock for first isolation



Monoblock for first isolation



+

Pipeline with flange connection

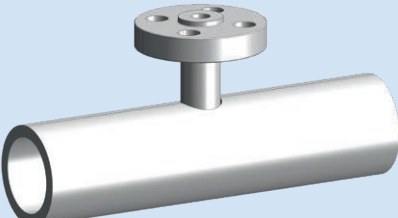



+

Monoblock

Mounting accessories



IBF1
Block

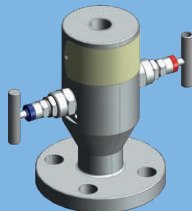

IBF2
Block-and-bleed



IBF3
Double-block-and-bleed

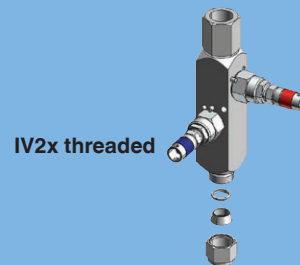

IV2x threaded

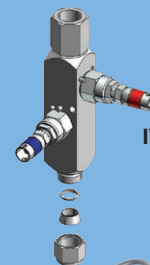

IV2x compression fitting



Connection adapter



Precision pipe
(customer supplied)

+



Flange adapter

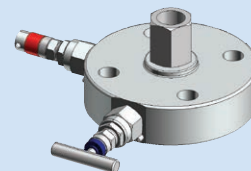

IVM
Monoflange



IBF1, IBF2, IBF3
Monoblock

+

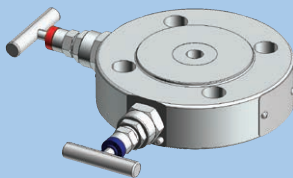

Sandwich monoflange IVM

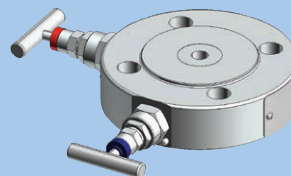

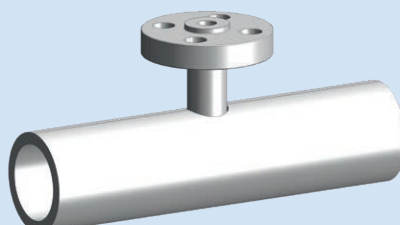

+







Pipeline with flange connection

The products in comparison

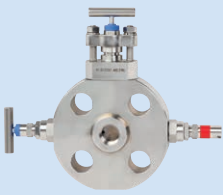
				
	Needle valve, block-and-bleed valve	Valve manifold	Ball valve	Check valve
Model	IV1, IV2	IV3, IV5	BV	CV
Gas application	◆	◆	◆	◆
Application with liquids	◆	◆	◆	◆
Cryogenic version	◆	◆	◆	◆
Fire-safety tested	◆	◆	Process version: ISO 10497 3rd ed., API 607 7th ed.	◆
Fugitive-emission tested	TA Luft, ISO 15848-1	TA Luft, ISO 15848-1	◆	◆
Reference standards	ASME B16.34, ASME B1.20.1, ASME B31.3, MSS SP-99	ASME B16.34, ASME B1.20.1, ASME B31.3, MSS SP-99	ASME B16.34, ASME B1.20.1, ASME B31.3, MSS SP-99, ASMEBPVC, ASMEB.31.1, ISO 17292, ASME B16.5	ASME B16.34, ASME B1.20.1, MSS SP-99
Assembly with measuring instrument (instrument hook-up)	◆	◆	◆	◆
Sealing packing and min. working temperature	PTFE, RTFE and graphite (min. temperature -55 °C)	PTFE, RTFE and graphite (min. temperature -55 °C)	PEEK, high-temperature thermoplastic (HTT) (min. temperature -55 °C)	NBR, FKM and PTFE (min. temperature -55 °C)
Data sheet	AC 09.22	AC 09.19	AC 09.28	AC 09.29
For details, see page	12	13	14	14

The information in the table above serves only as a reference and any application should be evaluated in accordance with the project specifications. WIKA can provide technical support in the evaluation of the best solution for your applications.

			
Monoflange, process and instrument version	Monoblock with flange connection	Monoblock with threaded connection	Monoblock for sampling and injection processes
IVM	IBF	IBM	IBS, IBJ
◆	◆	◆	◆
◆	◆	◆	◆
◆	◆	◆	◆
Bonnet: ISO 10497:2010, API 6FA:2018, API 607:2016	ISO 10497 and API 607	ISO 10497 and API 607	ISO 10497 and API 607
TA Luft, ISO 15848-1	◆	◆	◆
ASME B16.34, ASME B1.20.1, ASME B31.3, MSS SP-99, ASME B.31.1, ISO 17292, ASME B16.5	EEMUA 182, ASME B16.34, ASME B1.20.1, ASME B31.3, MSS SP-99, ASME BPVC, ASME B.31.1, ISO 17292, ASME B16.5	EEMUA 182, ASME B16.34, ASME B1.20.1, ASME B31.3, MSS SP-99, ASME BPVC, ASME B.31.1, ISO 17292, ASME B16.5	EEMUA 182, ASME B16.34, ASME B1.20.1, ASME B31.3, MSS SP-99, ASME BPVC, ASME B.31.1, ISO 17292, ASME B16.5
◆	◆	◆	◆
PTFE, RTFE and graphite (min. temperature -55 °C)	PEEK, PTFE, RTFE and graphite (min. temperature -55 °C), high-temperature thermoplastic (HTT)	PEEK, PTFE and graphite (min. temperature -55 °C), high-temperature thermoplastic (HTT)	PEEK, PTFE, RTFE and graphite (min. temperature -55 °C), high-temperature thermoplastic (HTT)
AC 09.17	AC 09.25	AC 09.24	AC 09.26
15	16	16	17

Legend:

- ◆ possible
- ◆ not possible

YouTube video
Which is the right valve for
my pressure measuring
instrument?



Needle and multiport valve Models IV10, IV11

Description

Needle valves and multiport valves separate the process from measuring instruments such as pressure gauges, switches or transmitters. By closing this valve the instrument can be safely dismantled for services like recalibration or replacement.

With the vent connection option, the instrument can be vented to the atmosphere by means of the needle valve.

Already in the standard version, the multiport valve is equipped with two additional connections. These can be used either as vent connections or for the connection of additional instruments.

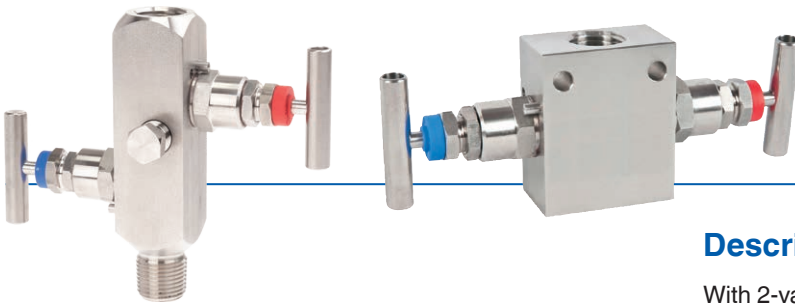
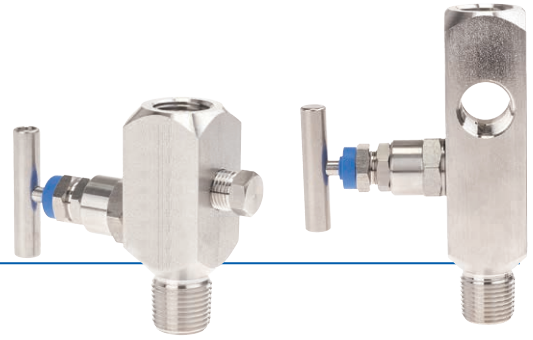

Block-and-bleed valve Models IV20, IV21

Description

With 2-valve manifolds, the block-and-bleed version is standard. The shut-off valve separates the process from measuring instruments such as pressure gauges, switches or transmitters. By closing this valve the instrument can be safely dismantled for services like recalibration or replacement. The vent valve allows the safe venting of the instrument, prior to the dismantling or for zero point check.



Valve manifold for differential pressure measuring instruments, 3-valve manifold Models IV30, IV31

Description

The 3-valve manifold consists of two shut-off valves and one pressure compensating valve. The shut-off valves separate the process from the differential pressure measuring instrument. The pressure compensating valve enables the compensation between \oplus side and \ominus side to avoid one-sided overload during commissioning and operation.

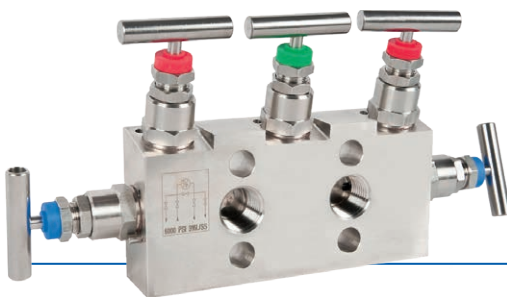
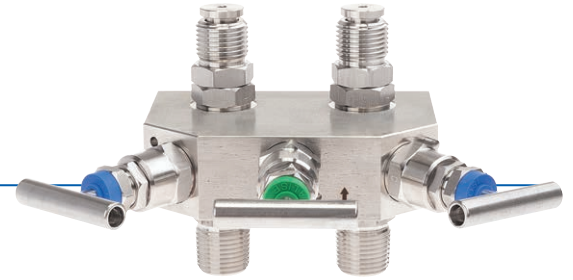

Valve manifold for differential pressure measuring instruments, 5-valve manifold Models IV50, IV51

Description

Compared to the 3-valve manifold, the 5-valve manifold is equipped with two additional vent valves. One vent valve per pressure side allows operators the targeted venting of one or both pressure sides of the measuring arrangement.



Ball valve, process and instrument version Model BV

Description

The simple and robust design, with a safety factor of 4:1, enables model BV ball valves a wide spectrum of use. This ranges from the simple distribution of compressed air through to demanding applications in the oil and gas industry. The process version of the ball valve has been designed to meet the requirements of the process industry, in particular for natural gas and aggressive media applications.

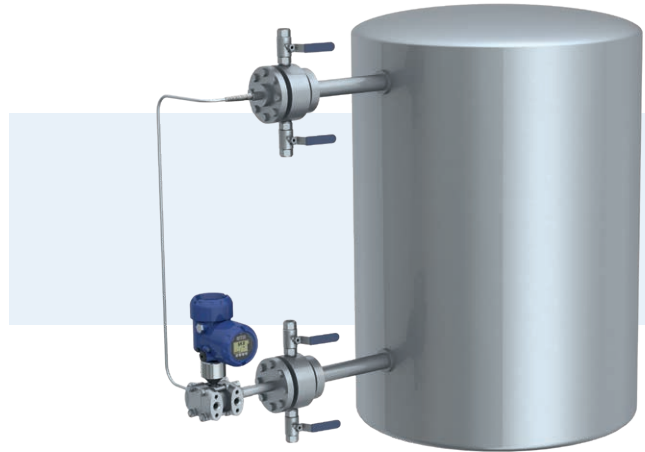
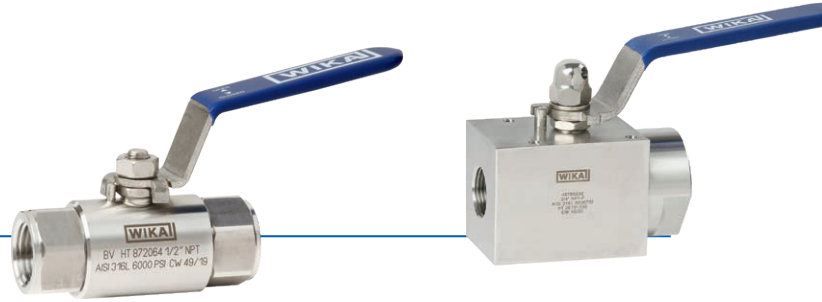

Check valve Model CV

Description

The sealing element (piston) has a double sealing system from an elastic O-ring and a metal cone. With any back pressure, the soft O-ring and then the sealing face of the metal cone prevent the reverse flow of the medium. This principle of double sealing ensures reliable leak tightness.

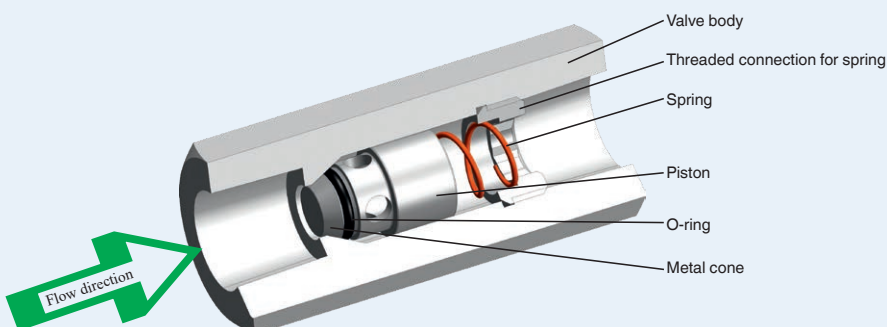

Monoflange, process and instrument version Model IVM

Description

Due to its one-piece design, the model IVM monoflange can withstand high overpressures. It ensures a robust and compact mounting of the measuring instrument directly to the process flange. The use of metal and graphite seals allows working at high temperatures.

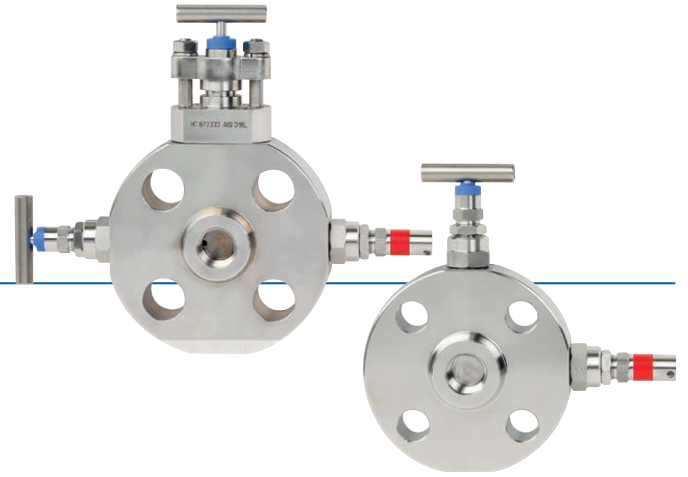

YouTube video
What is a monoflange? | Function,
versions and fields of application



Different combinations for monoflanges in process and instrument version

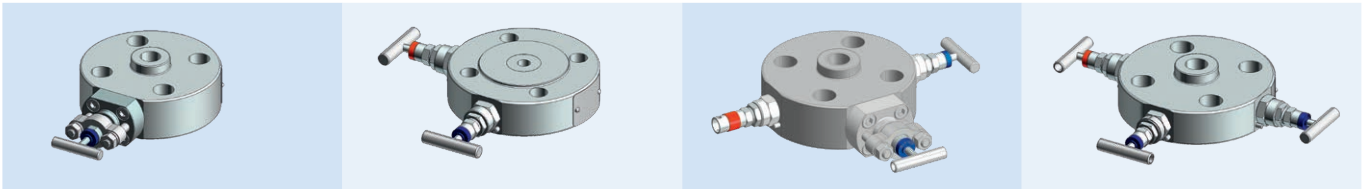

Special connections (IEC 61518 and union nut)

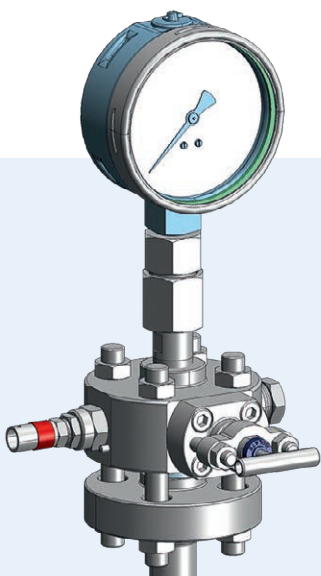
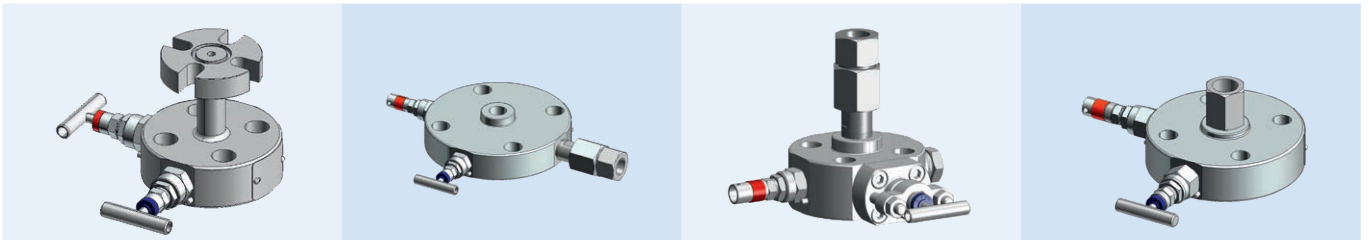

Monoblock with threaded connection Models IBM2, IBM3



Description

The monoblock has been designed specifically to fit into the small space of control panel and valve battery installations. With its very compact dimensions, the monoblock can be used in a wide range of applications providing high overpressure safety within a large spectrum of temperature ranges. The modular monoblock design allows using an arrangement of ball valves and/or needle valves in the same valve body.

Blog
Play it safe with double
block & bleed



Monoblock with flange connection Models IBF1, IBF2, IBF3



Description

The monoblock has been designed to meet the requirements of the process industry, especially for natural gas and aggressive media applications. The compact design integrates one or two shut-off valves to separate the process from the instrument side and a vent valve.

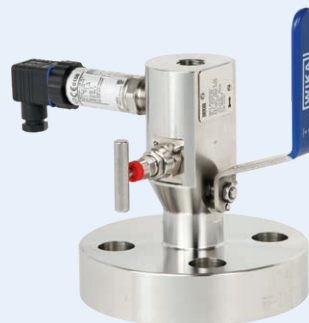

High-pressure needle valve Model HPV

Description

The model HPV high-pressure needle valves have been developed for high-pressure applications of 15,000 ... 60,000 psi (1,034 ... 4,136 bar). The valve is particularly suitable for control panels, where the space is restricted, or for test benches.

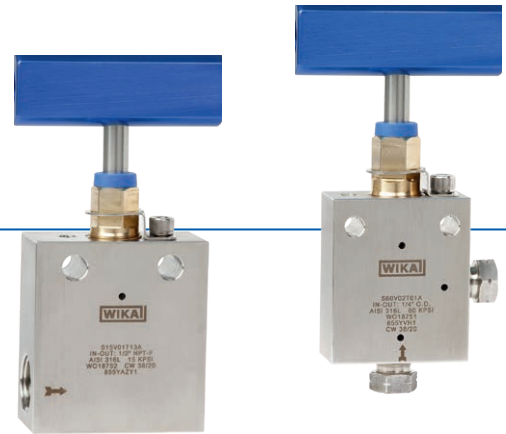

The non-rotating valve spindle prevents seizing and scoring, even if the valve is rarely opened or only partially closed.

With the blow-out proof design of the valve, working safety is ensured, especially in applications with high pressure loading and frequent pressure cycles.



Monoblock for sampling and injection processes Models IBS3, IBJ4

Description

The monoblock with probe for sampling and injection processes has been designed to meet the requirements of the process industry. It is especially well suited to applications in natural gas and aggressive media. The compact design integrates two shut-off valves to separate the process from the instrument side.

Model IBS3, for sampling processes

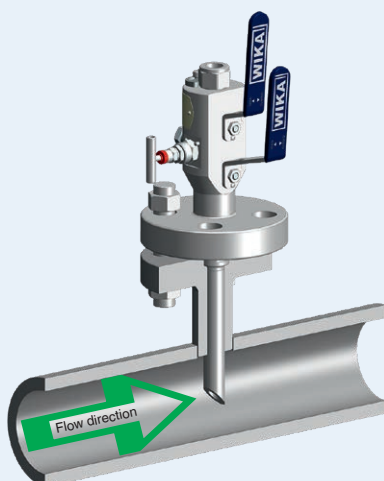

Model IBJ4, for injection processes

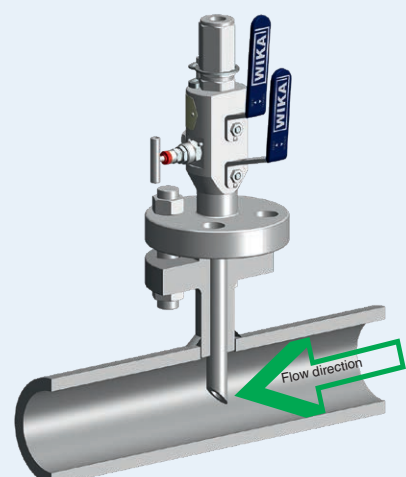

Stopcock Model 910.10

Specifications per data sheet:

AC 09.01

Design:

- DIN 16261: PN 16 cocks with female/female and female/male connection for pressure gauges
- DIN 16262: PN 6 and PN 16 cocks with adjusting nut and male connection for pressure gauges
- DIN 16263: PN 16 cocks with adjusting nut and male connection and test connection for pressure gauges

Max. medium temperature:

+50 °C

Nominal pressure:

To 25 bar

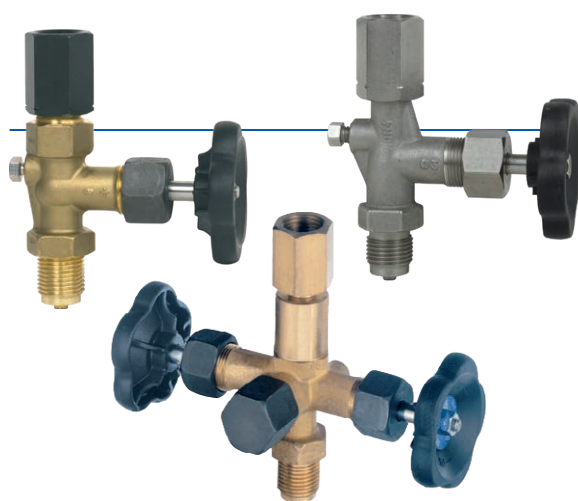
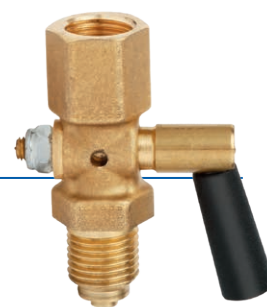

Shut-off valve Model 910.11

Specifications per data sheet:

AC 09.02

Design:

- DIN 16270: With vent screw
- DIN 16271: With test connection M20 x 1.5 and vent screw
- DIN 16272: With separate isolating test connection M20 x 1.5

Form A

LH-RH adjusting nut - male

Form B

Nipple and union nut - male, with shaft for instrument mounting bracket

Max. medium temperature:

- Brass: PN 250 (G ¼ thread: PN 125)
- Steel / Stainless steel: PN 400





Snubbers, adjustable Model 910.12

Specifications per data sheet:

AC 09.03

Design:

Brass, steel and stainless steel 316Ti / 1.4571

Max. medium temperature:

+120 °C

Snubbers are used to reduce the effects of pressure surges on the measuring instrument.

Operating principle

to the pressure measuring instrument

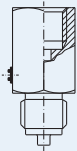

Adjustment screw

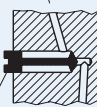

from the measuring location

Overpressure protector, adjustable Model 910.13

Specifications per data sheet:

AC 09.04

Design:

Valve body from brass or stainless steel 316Ti / 1.4571

Setting ranges:

0.4 ... 2.5 bar / 2 ... 6 bar / 5 ... 25 bar / 20 ... 60 bar /
50 ... 250 bar / 240 ... 400 bar

Max. temperature:

+130 °C

Through a helical spring, the outlet position is maintained until the pressure acting on the piston overcomes the back pressure of the spring, thus closing the valve. Once the pressure drops, the valve opens again and the piston returns to its resting position.

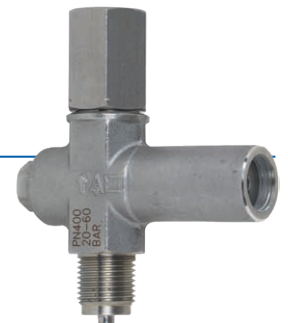

Form A, LH-RH adjusting nut/male

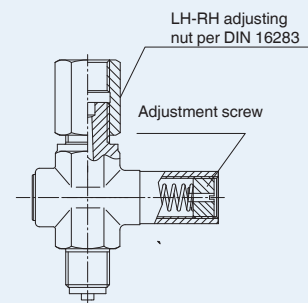

Syphon Model 910.15

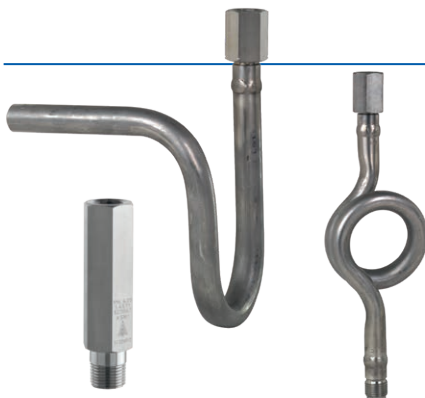

Specifications per data sheet:

AC 09.06

Design:

DIN 16282 / Industrial standard designs

Form:

U-form / trumpet form / compact syphon

Max. operating pressure and temperature:

- 104 bar / 400 °C
- 120 bar / 300 °C
- 160 bar / 120 °C
- 420 bar / 100 °C (compact syphon)

Connection adapter Model 910.14

Specifications per data sheet:

AC 09.05

Design:

- Female - male
- Female - female
- Male - male
- Self-sealing connecting nipple
- LH-RH adjusting nut DIN 16283
- Union nut and nipple DIN 16284
- Compression fitting with ferrule

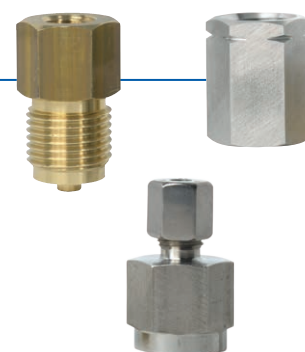

Instrument mounting bracket Model 910.16

Specifications per data sheet:

AC 09.07

Design:

- Instrument mounting bracket for connection via adapter: Bracket per DIN 16281 form H for wall mounting and form A for wall, pipe and support mounting
- Bracket for pipe mounting
- Adapter
- Instrument mounting bracket for connection without adapter: Bracket for wall mounting or pipe mounting



Sealings Model 910.17

Specifications per data sheet:

AC 09.08

Design:

- WIKA sealing
- Flat gasket
- Edge sealing ring

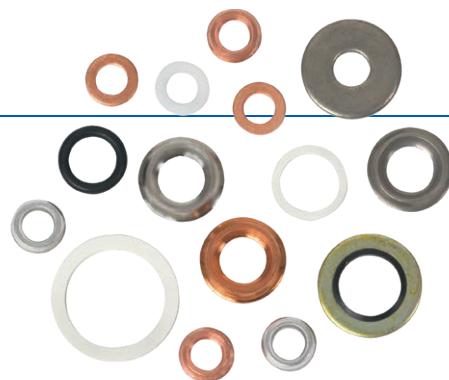

Special applications

Blog
Combination of pressure measuring instrument with accessories – Hook-up instead of own assembly



Mounting arrangements



Diaphragm seal assembly

Instrument hook-up

WIKA is happy to support you in the selection of the correct components for your application. Alongside the extensive selection of instrumentation valves and accessories, WIKA also offers qualified assembly of different individual components into a complete measuring arrangement (“instrument hook-up”).

In addition to the valves and protective devices described here, combination with diaphragm seal systems is also possible.

Flushing ring

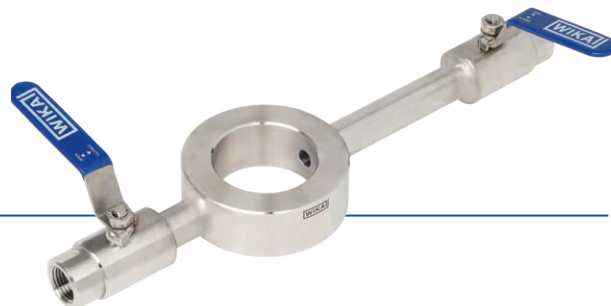

Flushing rings enable cleaning and maintenance of the measuring location without time-consuming dismantling of the measuring system. Cleaning is carried out via the bore of the flushing ring. For a problem-free supply of the respective cleaning medium, a needle valve or a ball valve, for example, can be mounted to the flushing ring. Due to their high-quality workmanship, WIKA needle valves enable precise control of the media flow, even at high pressures.

WIKA ball valves can be used, in particular, with viscous cleaning liquids.

The function of the flushing ring, in conjunction with an upstream shut-off valve, also enables simple on-site calibration of the measuring location. The process can also be vented or drained via the bore and valve. With the aid of the flushing ring, users can also take samples of the process medium.

Advantages

- Easy cleaning and maintenance
- On-site calibration
- Venting of the process
- Sampling

Model 910.27 flushing rings, with appropriate connections and materials, can be adapted to almost any application. There are versions with a bore on one or both sides, which are suitable for a wide range of cleaning applications. Installation is simple and leak-free.

Special solutions



Flushing ring for flange-connection diaphragm seals



Needle valve, block-and-bleed valve



Monoflange, process and instrument version



Monoblock with flange connection



Ball valve

For use at low temperatures

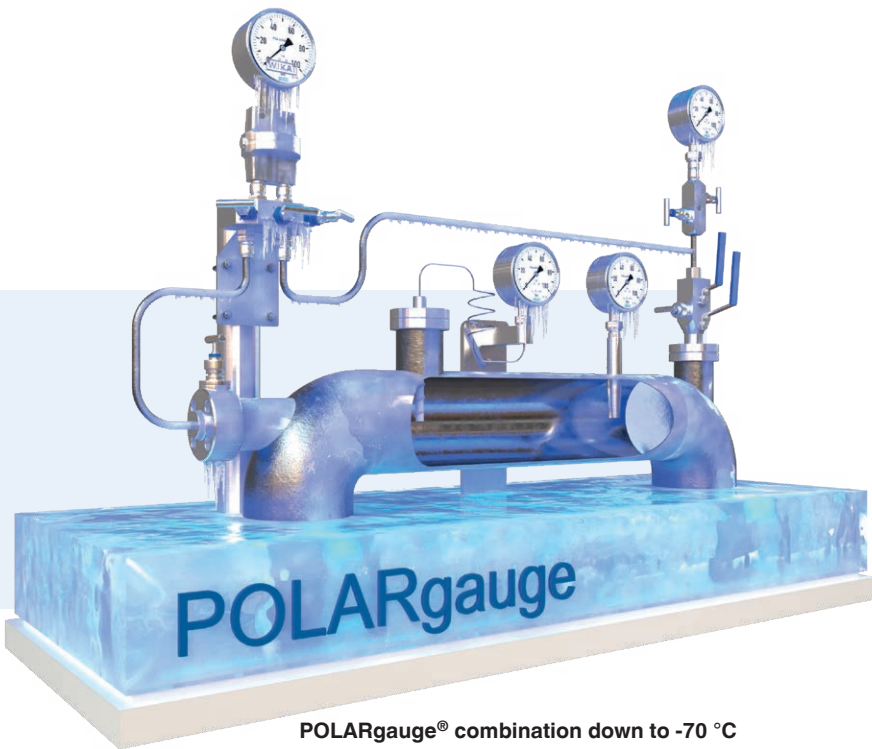

POLARgauge® combination down to -70 °C

The POLARgauge® and POLARvalve series have been designed specifically for measurement at extremely low ambient temperatures down to -70 °C. The instruments are mainly used in crude oil and natural gas processing.

For this product family, a special low-temperature silicone oil has been specified. Even at -70 °C, this oil remains in a state that enables correct measurement and measured value display.

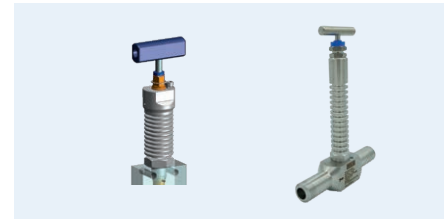

Option: Cryogenic needle valve bonnet down to -196 °C

Other versions of needle and ball valves



Certificates and approvals

Given the increasing demands in terms of quality and product safety of industrial products, certified measuring instruments for pressure contribute considerably to the safety of the production processes. Therefore we offer a wide range of approvals and certificates.

Tests

- PMI test
- Roughness measurement
- Coating thickness measurement
- Dye penetrant test
- Surface roughness
- Leak test
- Pressure test

Approvals

- Pressure equipment directive
- EHEDG
- 3-A
- FDA
- NACE
- BAM
- EAC
- GOST
- ATEX

Certificates

- Ingress protection
- Material proof
- RoHS
- Oil- and grease-free
- Accuracies of the span
- Switching accuracy
- Indication accuracy



WIK A worldwide

Europe

Austria

WIK A Messgerätevertrieb
Ursula Wiegand GmbH & Co. KG
Tel. +43 1 8691631
info@wika.at / www.wika.at

Benelux

WIK A Benelux
Tel. +31 475 535500
info@wika.nl / www.wika.nl

Bulgaria

WIK A Bulgaria EOOD
Tel. +359 2 82138-10
info@wika.bg / www.wika.bg

Croatia

WIK A Croatia d.o.o.
Tel. +385 1 6531-034
info@wika.hr / www.wika.hr

Denmark

WIK A Danmark A/S
Tel. +45 4581 9600
info@wika.as / www.wika.as

Finland

WIK A Finland Oy
Tel. +358 9 682492-0
info@wika.fi / www.wika.fi

France

WIK A Instruments s.a.r.l.
Tel. +33 1 787049-46
info@wika.fr / www.wika.fr

Germany

WIK A Alexander Wiegand SE & Co. KG
Tel. +49 9372 132-0
info@wika.de / www.wika.de

Italy

WIK A Italia S.r.l. & C. S.a.s.
Tel. +39 02 93861-1
info@wika.it / www.wika.it

Poland

WIK A Polska spółka z ograniczoną
odpowiedzialnością sp. k.
Tel. +48 54 230110-0
info@wikapolska.pl
www.wikapolska.pl

Romania

WIK A Instruments Romania S.R.L.
Tel. +40 21 4048327
info@wika.ro / www.wika.ro

Russia

AO "WIK A MERA"
Tel. +7 495-648018-0
info@wika.ru / www.wika.ru

Serbia

WIK A Merna Tehnika d.o.o.
Tel. +381 11 2763722
info@wika.rs / www.wika.rs

Spain

Instrumentos WIK A S.A.U.
Tel. +34 933 9386-30
info@wika.es / www.wika.es

Switzerland

WIK A Schweiz AG
Tel. +41 41 91972-72
info@wika.ch / www.wika.ch

Türkiye

WIK A Instruments
Endüstriyel Ölçüm Cihazları Tic. Ltd. Şti.
Tel. +90 216 41590-66
info@wika.com.tr
www.wika.com.tr

Ukraine

TOV WIK A Prylad
Tel. +38 044 496 83 80
info@wika.ua / www.wika.ua

United Kingdom

WIK A Instruments Ltd
Tel. +44 1737 644-008
info@wika.co.uk / www.wika.co.uk

North America

Canada

WIK A Instruments Ltd.
Tel. +1 780 4637035
info@wika.ca / www.wika.ca

USA

WIK A Instrument, LP
Tel. +1 770 5138200
info@wika.com / www.wika.us

Gayesco-WIK A USA, LP

Tel. +1 512 3964200
info@wika-houston.com
www.wika.us

Mensor Corporation

Tel. +1 512 3964200
sales@mensor.com
www.mensor.com

Latin America

Argentina

WIK A Argentina S.A.
Tel. +54 11 5442 0000
ventas@wika.com.ar
www.wika.com.ar

Brazil

WIK A do Brasil Ind. e Com. Ltda.
Tel. +55 15 3459-9700
vendas@wika.com.br
www.wika.com.br

Chile

WIK A Chile S.p.A.
Tel. +56 9 4279 0308
info@wika.cl / www.wika.cl

Colombia

Instrumentos WIK A Colombia S.A.S.
Tel. +57 601 7021347
info@wika.co / www.wika.co

Mexico

Instrumentos WIK A Mexico S.A. de C.V.
Tel. +52 55 50205300
ventas@wika.com / www.wika.mx

Asia

China

WIK A Instrumentation Suzhou Co., Ltd.
Tel. +86 512 6878 8000
info@wika.cn / www.wika.com.cn

India

WIK A Instruments India Pvt. Ltd.
Tel. +1800-123-101010
info@wika.co.in / www.wika.com.in

Japan

WIK A Japan K. K.
Tel. +81 3 5439-6673
info@wika.co.jp / www.wika.co.jp

Kazakhstan

TOO WIK A Kazakhstan
Tel. +7 727 225 9444
info@wika.kz / www.wika.kz

Korea

WIK A Korea Ltd.
Tel. +82 2 869-0505
info@wika.co.kr / www.wika.co.kr

Malaysia

WIK A Instrumentation (M) Sdn. Bhd.
Tel. +60 3 5590 6666
info@wika.my / www.wika.my

Philippines

WIK A Instruments Philippines Inc.
Tel. +63 2 234-1270
info@wika.ph / www.wika.ph

Singapore

WIK A Instrumentation Pte. Ltd.
Tel. +65 6844 5506
info@wika.sg / www.wika.sg

Taiwan

WIK A Instrumentation Taiwan Ltd.
Tel. +886 3 420 6052
info@wika.tw / www.wika.tw

Thailand

WIK A Instrumentation Corporation
(Thailand) Co., Ltd.
Tel. +66 2 326 6876
info@wika.co.th / www.wika.co.th

Uzbekistan

WIK A Instrumentation FE LLC
Tel. +998 71 205 84 30
info@wika.uz / www.wika.uz

Africa/Middle East

Botswana

WIK A Instruments Botswana (Pty.) Ltd.
Tel. +267 3110013
info@wika.co.bw / wika.co.bw

Egypt

WIK A Near East Ltd.
Tel. +20 2 240 13130
info@wika.com.eg / www.wika.com.eg

Namibia

WIK A Instruments Namibia Pty Ltd.
Tel. +26 4 61238811
info@wika.com.na / www.wika.com.na

Nigeria

WIK A WEST AFRICA LIMITED
Tel. +234 17130019
info@wika.com.ng / www.wika.ng

Saudi Arabia

WIK A Saudi Arabia LLC
Tel. +966 53 555 0874
info@wika.sa / www.wika.sa

South Africa

WIK A Instruments Pty. Ltd.
Tel. +27 11 62100-00
sales@wika.co.za / www.wika.co.za

United Arab Emirates

WIK A Middle East FZE
Tel. +971 4 883-9090
info@wika.ae / www.wika.ae

Australia

Australia

WIK A Australia Pty. Ltd.
Tel. +61 2 88455222
sales@wika.com.au / www.wika.com.au

New Zealand

WIK A Instruments Limited
Tel. +64 9 8479020
info@wika.co.nz / www.wika.co.nz

WIK A Alexander Wiegand SE & Co. KG
Alexander-Wiegand-Straße 30 | 63911 Klingenberg | Germany
Tel. +49 9372 132-0 | info@wika.de | www.wika.de

14158213 04/2023 EN



You can find further
information here!



Smart in sensing

www.wika.com